

# MOBILITY 42G

7-in-1 Cellular & Wi-Fi Antenna System with GPS Receiver

## Overview

- Built for 5G**  
 Omni-directional 4x4 MIMO mobile antenna for the best performance.
- C-Band support**  
 Exceptional performance in 3.3 and 4.2 GHz frequency range allowing to get a massive throughput speed boost.
- Ultra wide bandwidth**  
 Wide frequency range (600-6000MHz) supporting LTE and 5G
- Wi-Fi**  
 2x2 MIMO dual band (2.4GHz & 5GHz) high gain omnidirectional antennas
- Robust design**  
 IP68 rated, low profile and durable housing in Black or White color options.

## Applications

- Public Safety and mission critical connectivity
- Mobile Healthcare
- Transportation Connectivity

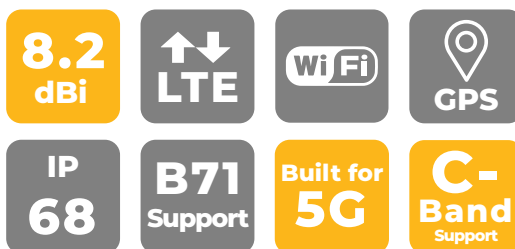

## Specification

### Cellular

Antenna elements	4 elements
Cellular frequencies <sup>#</sup>	4.4dBi@617-960MHz 7.8dBi@1710-2700MHz 7.9dBi@3400-4200MHz 8.2dBi@5000-6000MHz
Cellular bands	LTE bands B1 to B86 (except B31, B72, B73, B87, B88), 5G bands n1 to n99
VSWR	< 2.5 over 95% of the band
Feed power handling	10W
Input impedance	50 Ω
Polarisation	Linear
Ground plane	Not required

### Wi-Fi

Antenna elements	2 elements
Peak Gain & Frequencies	5.0dBi: 2400-2500MHz 7.5dBi: 5000-6000MHz
VSWR	< 2.5
Feed power handling	10W
Input impedance	50 Ω
Polarisation	Linear

### GPS

Frequency range	1561-1602 MHz
Peak Gain & Frequencies	0.5dBi@1575MHz 1.6dBi@1602MHz
VSWR	< 2 dB
Output return loss	10dB max
LNA Gain	28 ±3dB
Noise figure	1.5dB max at 3.3V
Operating Voltage	3.3V
Power consumption	8.5 ±2.5mA at 3.3V

### Cable (LTE / 5G, Wi-Fi)

Type	CFD-200
Loss	0.33 dB/m @ 900 MHz 0.49 dB/m @ 2000 MHz 0.55 dB/m @ 2500 MHz 0.87 dB/m @ 5800 MHz
Diameter	0.2" / 5.0mm
Jacket	Half matt PVC, UV resistant
Cellular Termination	QMA male, SMA male
Wi-Fi Termination	QMA male, RP-SMA male

### Cable (GPS)

Type	RG-174
Loss	3.4 dB/m @ 1000 MHz 4.9 dB/m @ 1800 MHz
Diameter	0.1" / 2.7mm
Jacket	Half matt PVC, UV resistant
Termination	QMA male, SMA male

### Mounting

Supported types	Panel, wall, pole
Mounting hole	1 11/16" / 43mm
Max panel thickness	19/32" / 15mm

### Mechanical

Product dimensions	(Height) 2.28" / 58mm (spigot not included) (Diameter) 8.19" / 208mm
Packaged dimensions	9.09" x 8.50" x 6.14" 231 x 216 x 156 mm
Radome material	UV stable PC

### Package contents

Antenna	Mobility 42G
Accessories	Wall/pole mount Double sided 3M adhesive pad (Diameter: 8.19" / 208 mm Thickness: 0.08" / 2 mm)

### Environmental, compliance

IP rating	IP68
Operating temperature	-40° - 176°F / -40° - 80°C
Storage temperature	-40° - 176°F / -40° - 80°C
Compliance	RoHS, REACH, WHEE
Wind Survivability	137mph, 220 km/h
Enclosure flammability	UL 94 HB
Cable flammability	UL 758 (VW-1)
UV resistance	UL 746C (F1 long-term UV exposure)
Salt Spray	MIL-STD 810F/ASTM B117

Mobility 42G

<sup>#</sup> Measured peak Gain on 600x600mm (23.6"x23.6") ground plane excluding cable loss.

## Ordering Information

### Mobility 42G

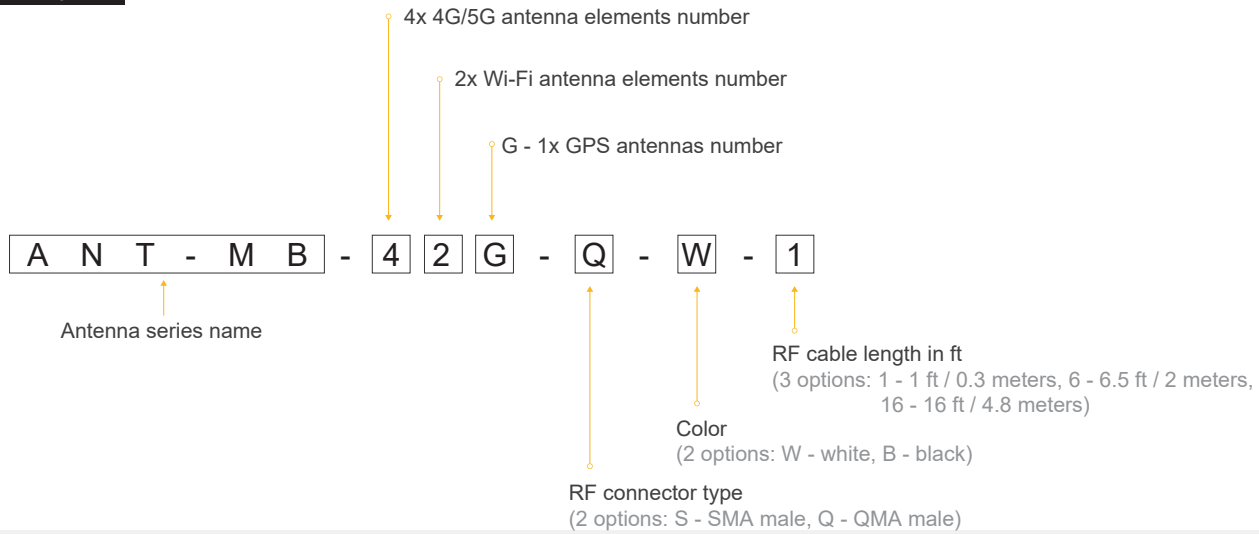

Product Code	Description
ANT-MB-42G-S-W-1	4xLTE/5G, 2x Wi-Fi, 1xGPS 600-6000MHz, IP68, SMA male (Cellular, GPS), RP-SMA male (Wi-Fi), White, 1 ft / 0.3m
ANT-MB-42G-S-B-1	4xLTE/5G, 2x Wi-Fi, 1xGPS 600-6000MHz, IP68, SMA male (Cellular, GPS), RP-SMA male (Wi-Fi), Black, 1 ft / 0.3m
ANT-MB-42G-S-W-6	4xLTE/5G, 2x Wi-Fi, 1xGPS 600-6000MHz, IP68, SMA male (Cellular, GPS), RP-SMA male (Wi-Fi), White, 6.5 ft / 2m
ANT-MB-42G-S-B-6	4xLTE/5G, 2x Wi-Fi, 1xGPS 600-6000MHz, IP68, SMA male (Cellular, GPS), RP-SMA male (Wi-Fi), Black, 6.5 ft / 2m
ANT-MB-42G-S-W-16	4xLTE/5G, 2x Wi-Fi, 1xGPS 600-6000MHz, IP68, SMA male (Cellular, GPS), RP-SMA male (Wi-Fi), White, 16 ft / 4.8m
ANT-MB-42G-Q-W-1	4xLTE/5G, 2x Wi-Fi, 1xGPS 600-6000MHz, IP68, QMA male, White, 1 ft / 0.3m
ANT-MB-42G-Q-W-6	4xLTE/5G, 2x Wi-Fi, 1xGPS 600-6000MHz, IP68, QMA male (Cellular, GPS), RP-SMA male (Wi-Fi), White, 6.5 ft / 2m
ANT-MB-42G-Q-B-1	4xLTE/5G, 2x Wi-Fi, 1xGPS 600-6000MHz, IP68, QMA male, Black, 1 ft / 0.3m
ANT-MB-42G-Q-B-6	4xLTE/5G, 2x Wi-Fi, 1xGPS 600-6000MHz, IP68, QMA male (Cellular, GPS), RP-SMA male (Wi-Fi), Black, 6.5 ft / 2m

### Extension cable

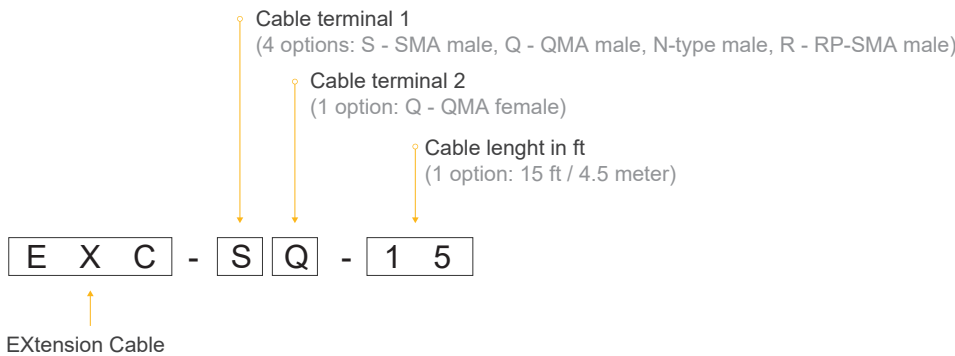

#### LTE/GPS elements

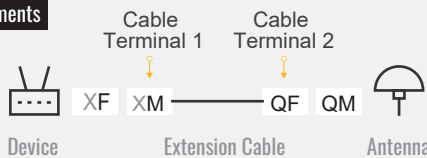

#### Wi-Fi elements

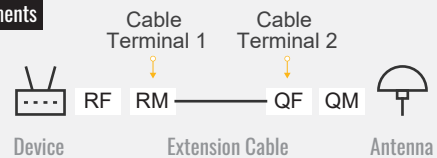

Product Code	Element type	Description
EXC-SQ-15	LTE/GPS elements	Extension coax cable, SMA male to QMA female connector, 15ft / 4.5m
EXC-QQ-15	LTE/GPS elements	Extension coax cable, QMA male to QMA female connector, 15ft / 4.5m
EXC-NQ-15	LTE/GPS elements	Extension coax cable, N-type male to QMA female connector, 15ft / 4.5m
EXC-RQ-15	Wi-Fi elements	Extension coax cable, RP-SMA male to QMA female connector, 15 ft / 4.5m

## Featured Add-on

Product Code	Description
ACW-661	3M Double-sided Adhesive Antenna Mounting Gasket
ACW-881	Wall/pole L-mount Antenna mounting kit (white)
ACW-884	Wall/pole L-mount Antenna mounting kit (black)
ACW-651	Maritime 1" 14TPI Female to Mobility Antenna thread
ACW-653	Maritime 1 1/4" 11TPI male adapter



Mobility 42G

Technical Drawing



Mobility 42G





## Cellular Antenna VSWR

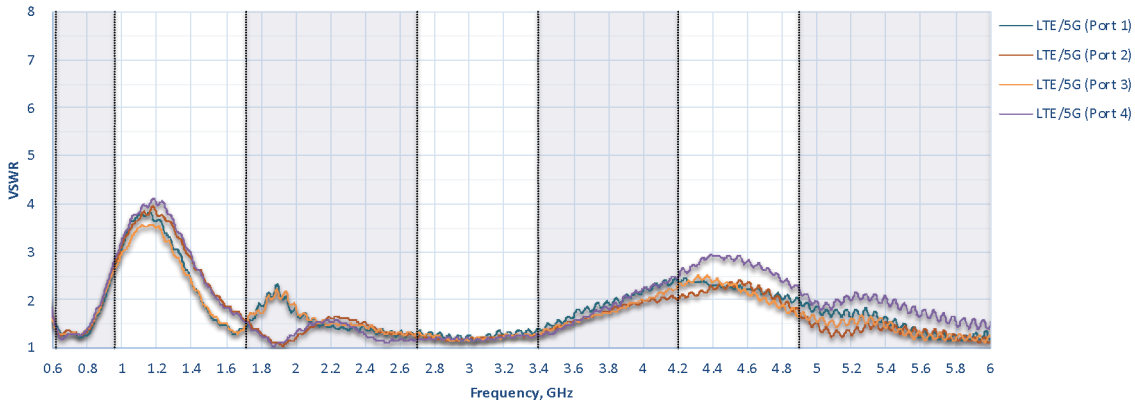

## Cellular Antenna Gain

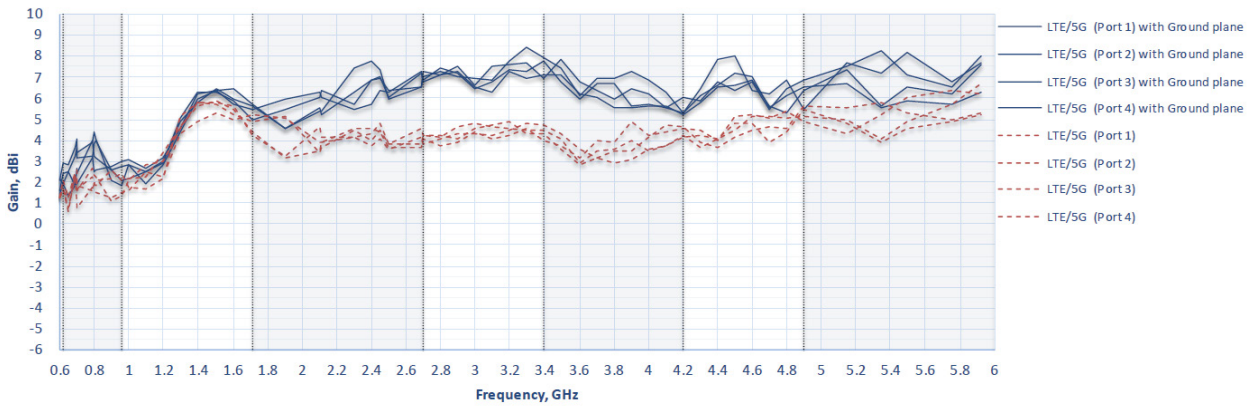

## Cellular Antenna Efficiency

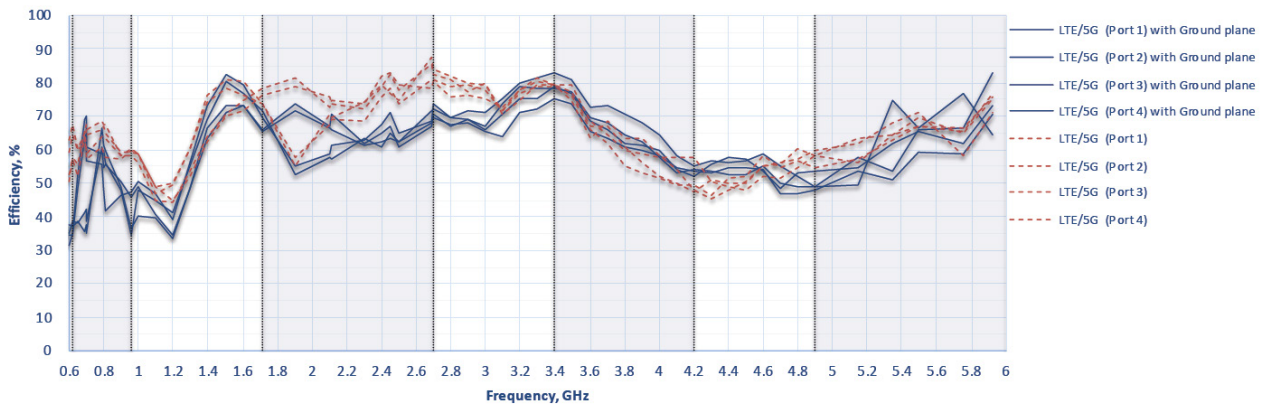

## Wi-Fi Antenna VSWR

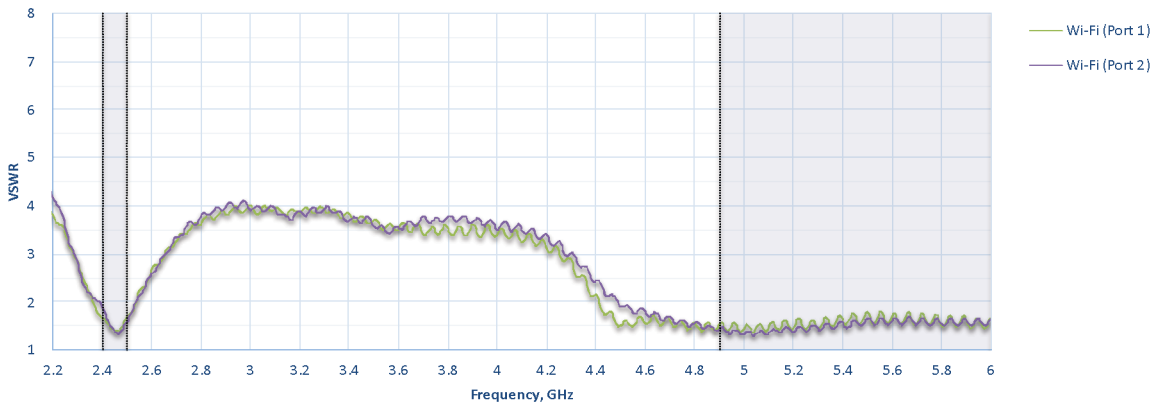

## Wi-Fi Antenna Gain

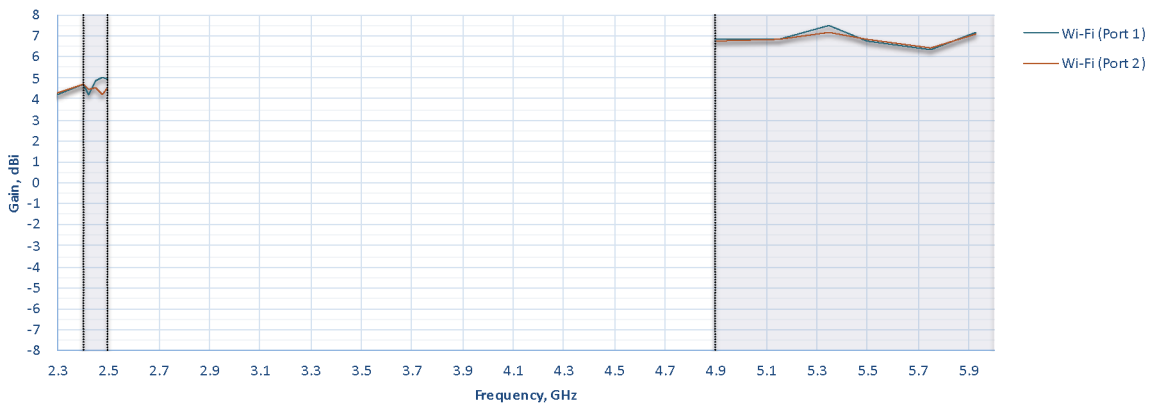

## Wi-Fi Antenna Efficiency

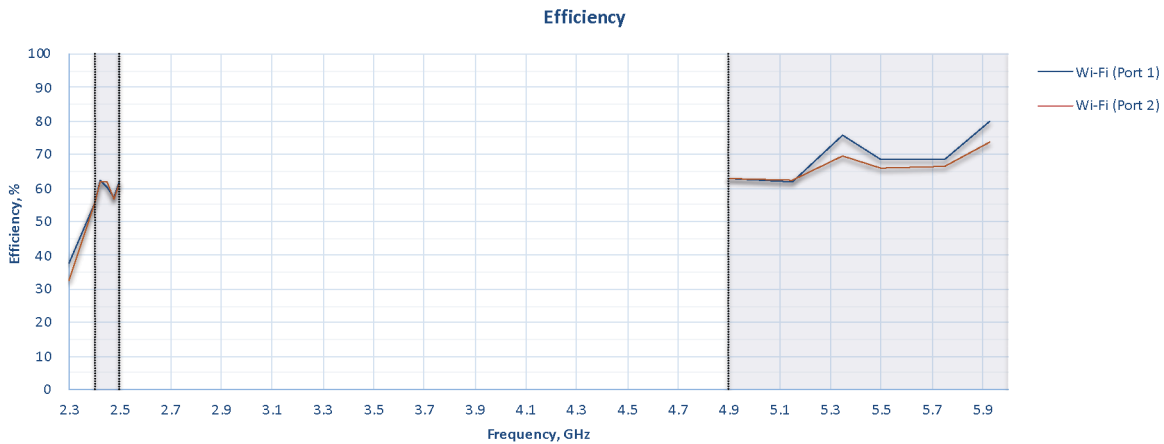

# Antenna Isolation

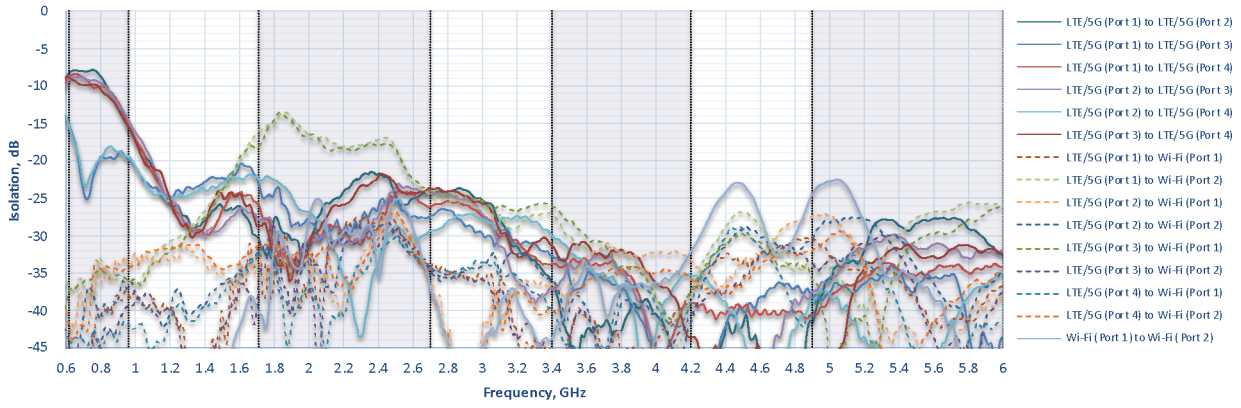



## LTE Radiation Patterns (Azimuth)

**617-960 MHz**

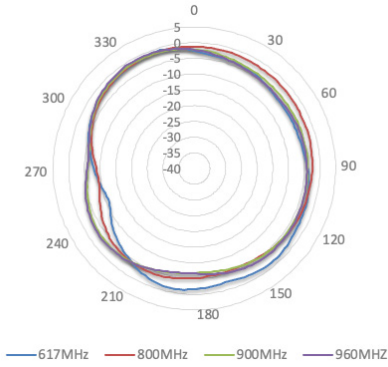

**3400-3800 MHz**

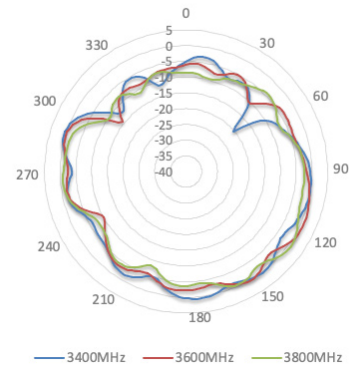

**1710-2100MHz**

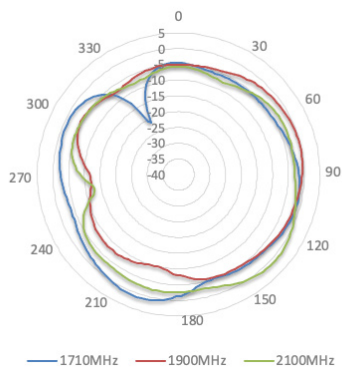

**4200-5150 MHz**

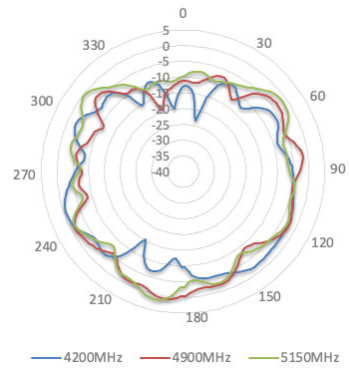

**2300-2700 MHz**

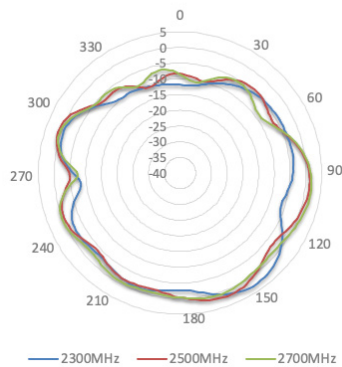

**5350-5925 MHz**

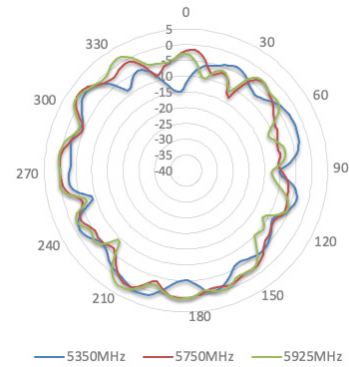

Mobility 42G

# LTE Radiation Patterns (Elevation 1)

617-960 MHz

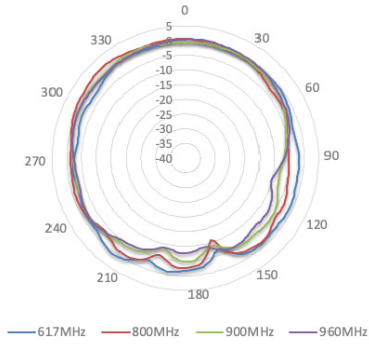

3400-3800 MHz

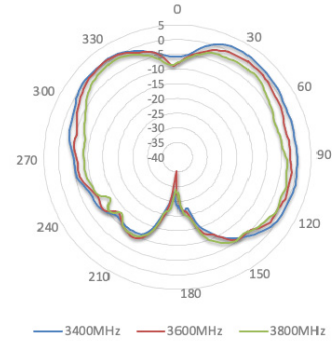

1710-2100MHz

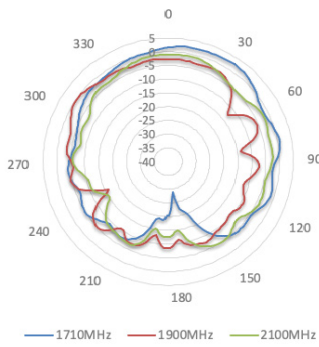

4200-5150 MHz

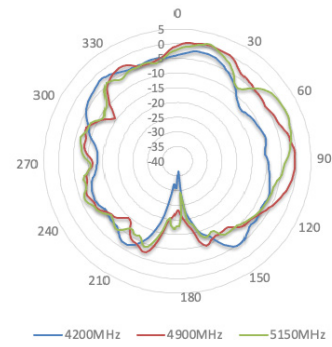

2300-2700 MHz

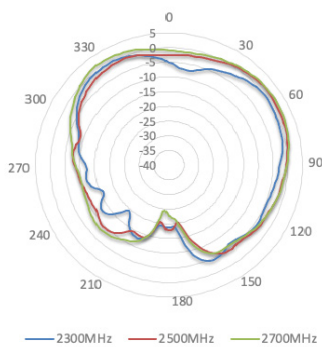

5350-5925 MHz

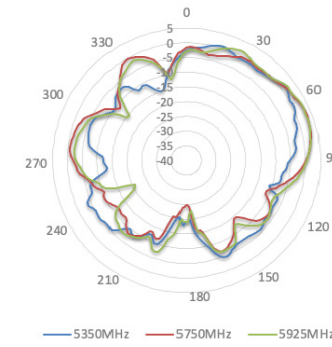

Mobility 42G

## LTE Radiation Patterns (Elevation 2)

617-960 MHz

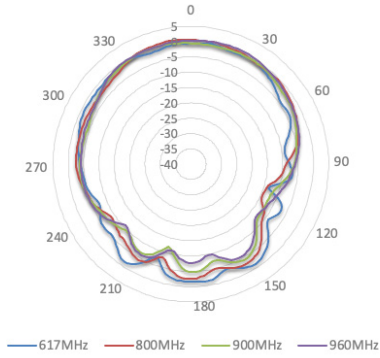

3400-3800 MHz

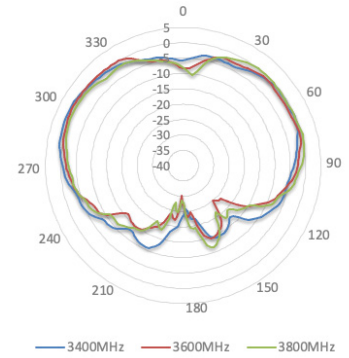

1710-2100MHz

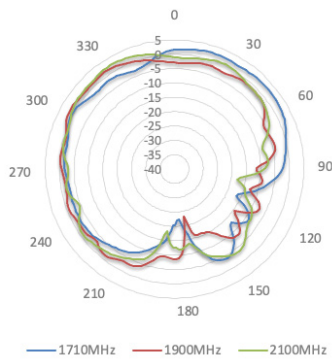

4200-5150 MHz

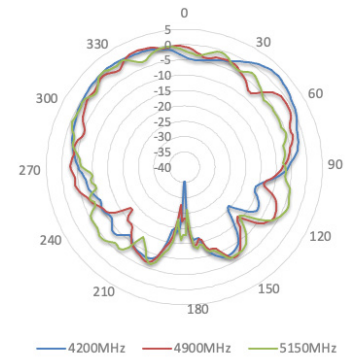

2300-2700 MHz

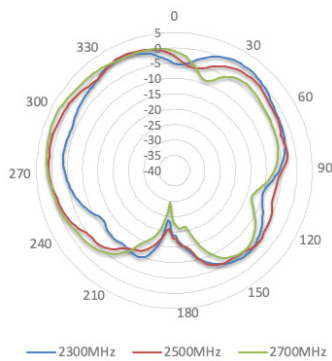

5350-5925 MHz

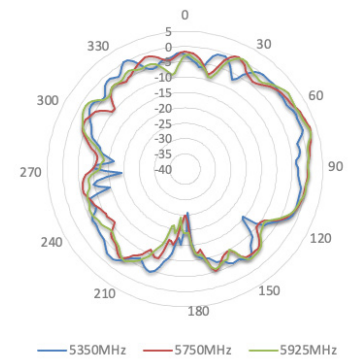

Mobility 42G

## Wi-Fi Radiation Patterns (Azimuth)

2400-2500 MHz

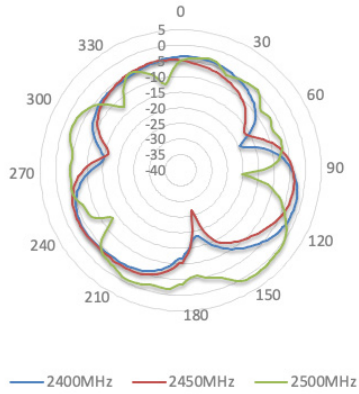

4900-5350 MHz

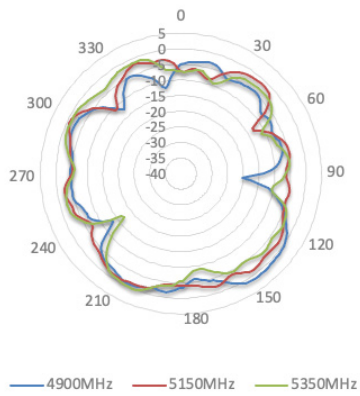

5550-5950 MHz

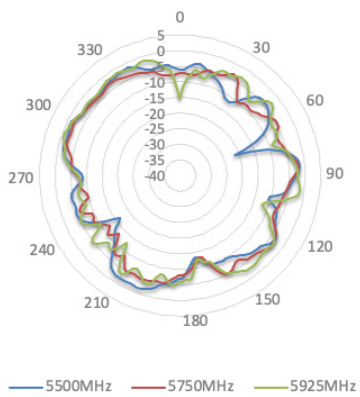

## Wi-Fi Radiation Patterns (Elevation 1)

2400-2500 MHz

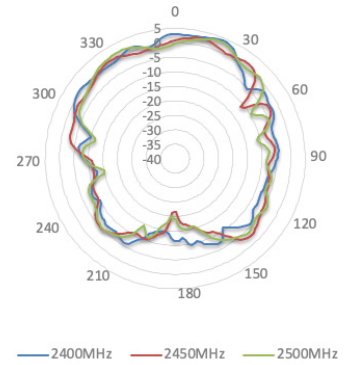

4900-5350MHz

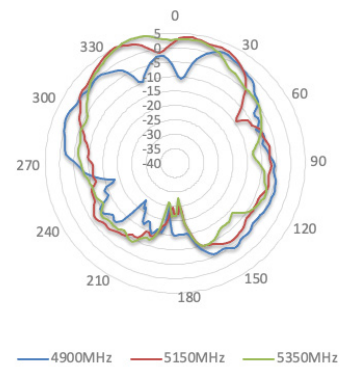

5550-5950 MHz

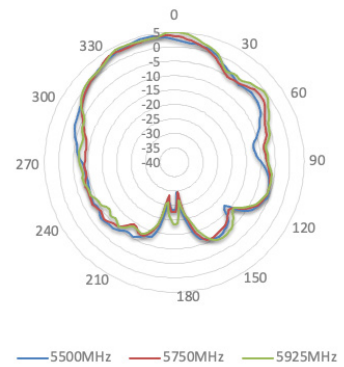

Mobility 42G

## Wi-Fi Radiation Patterns (Elevation 2)

### 2400-2500 MHz

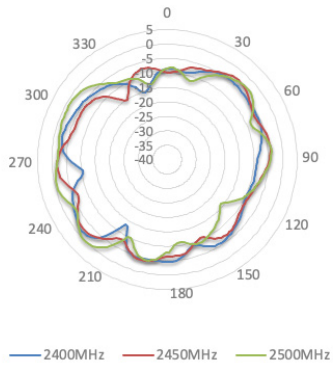

### 4900-5350 MHz

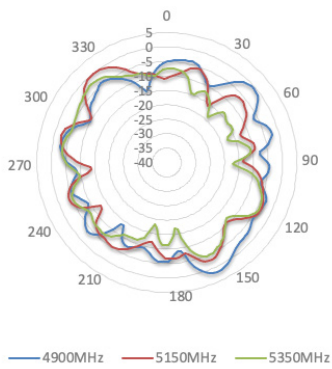

### 5550-5950 MHz

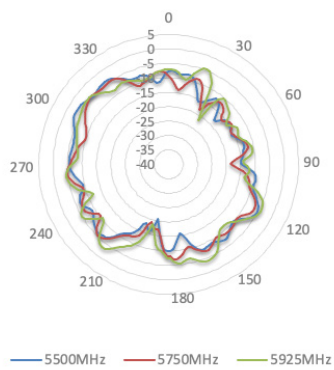

Mobility 42G

## Installation Recommendation

Panel Mount



# Mobility 42G

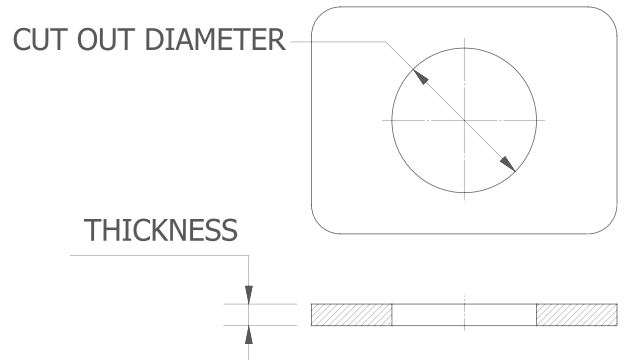

### Notes

- Cover panel surface to protect the paint work. When drilling a hole, start with a small one, then increase it.
- Cut out diameter should be 1 11/16" / 43mm.  
Maximum allowed panel thickness - 19/ 32" / 15mm.
- After drilling, clean up the surface and apply some paint around the hole to prevent corrosion. Attach the antenna.





## Installation Recommendation

Pole Mount



Mobility 42G





## Installation Recommendation

Horizontal Pole Mount



Mobility 42G





## Installation Recommendation

Wall Mount



Mobility 42G

